

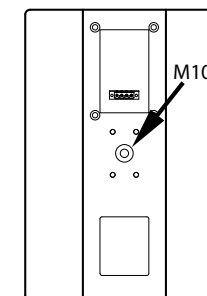

www.hortusaudio.eu

Contract[®] CT30MKII

CT30MKII

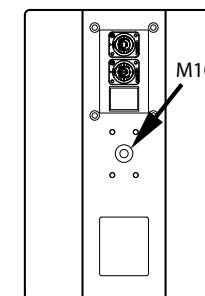
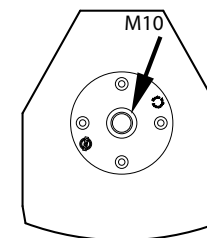
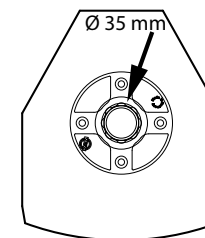
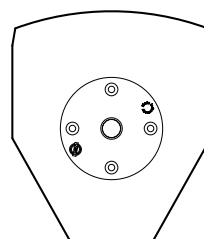
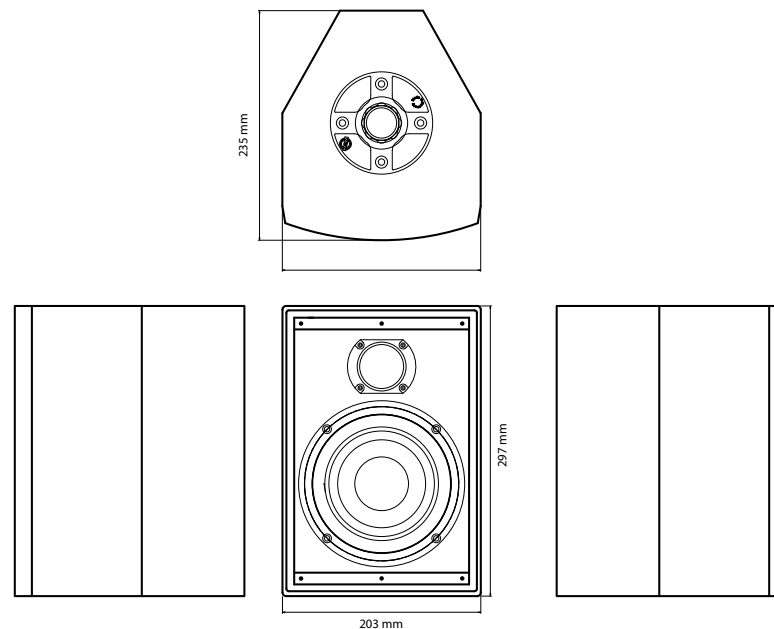

Speakon Version

Phoenix Version

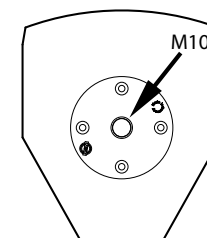
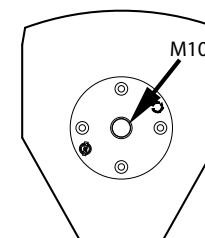

**Compact passive 2-way installation cabinet
woofer 6.5" (16 cm) + Poly dome neodymium tweeter
150 W RMS / 8 or 16 Ohms - 111 dB SPL Max**

- 8 or 16 ohms version
- Sensitivity 91 dB
- MAX measured SPL (on max. amplifier) 111 dB
- Incredible size / weight / power ratio
- Excellent power handling
- Humidity protected loudspeakers and UV resistant treatment
- Compact wood enclosure : MDF 12 mm with 1/2 cluster shape
- Dimensions (HxWxD) 297 x 203 x 235 mm / 11.7" x 8" x 9.3"
- Finish 2 layers of highly resistant structural polyurethane painting, available in black or white
- Multiple combinations of rigging hardware (M10 standard)
- Flange adapter 35 mm or connector plate M10
- Usable frequency (-6 db) 65 Hz - 21 KHz
- Nominal coverage 80° H x 80° V
- 2 connector versions : 2 Speakon NL4MP Neutrik™ or Phoenix™ connector
- Net weight : 4,5 kg / 9.9 lbs - Shipping weight : 5 kg / 11 lbs

CONTRACT series[®]